

USER MANUAL OF SMILE - G3 - S5



DISCLAIMER

Copyright © AlphaESS Co., Ltd. 2022. All rights reserved.

No part of this document may be reproduced or transmitted in any form or by any means without prior written consent of AlphaESS Co., Ltd.

The material furnished in this document is believed to be accurate and reliable. The information and recommendations in this document do not constitute commitments or warranties in the form of assignments. The information in this document is subject to change without notice. You may refer to the Alpha Cloud Platform (<https://cloud.alphaess.com>) for the most updated version.

All company and brand products and service names are trademarks or registered trademarks of their respective holders.

COPYRIGHT STATEMENT

This manual is under the copyright of Alpha ESS Co., Ltd. with all rights reserved. Please keep the manual properly and operate in strict accordance with all safety and operating instructions in this manual. Please do not operate the product before reading through the manual.



CONTENT

DISCLAIMER	1
COPYRIGHT STATEMENT	2
CONTENT	2
1. INTRODUCTION	4
1.1. Content and Structure of this Document	4
1.2. Levels of Warning Messages	5
2. Safety	6
2.1. Intended Use	6
2.2. Safety Instructions for Battery	7
2.2.1. General Safety Precautions	7
2.3. Symbols explanation	8
3. Product Introduction and Application Scenarios	10
3.1. System introduction	10
3.2. Product Description	10
3.2.1. Inverter Display Interface Introduction	10
3.3. Application Scenarios	11
3.3.1. DC-coupled Storage System	11
3.3.2. AC-coupled Storage System	12
3.3.3. Hybrid-coupled Storage System	12
4. Installer Account Register and Install New System	14
4.1. Register on APP	14
4.1.1. Download and Install the APP	14
4.1.2. Install New System	14
4.2. Register on AlphaCloud	15
4.2.1. Install New System	15
5. Powering On and Off the System	17
5.1. Powering on the System	17
5.2. Powering off the System	17
6. Maintenance and Troubleshooting	18
6.1. Routine Maintenance	18
6.2. Troubleshooting	19
6.2.1. Inverter Protection Description	25
6.2.2. Battery Protection Description	29
6.2.3. Battery Error Description	30
7. Uninstallation & Return	32
7.1. Removing the Product	32
7.2. Packing the Product	32
7.3. Disposing of the Product	32

8. Specification	33
8.1. Datasheet of Inverter SMILE-G3-INV	33
8.2. Datasheet of Battery	38
8.3. Safety Data Sheet	38

1. INTRODUCTION

1.1. Content and Structure of this Document

This document is valid for product of SMILE-G3 system which include inverter SMILE-G3-INV and battery Smile-G3-BAT.

This document describes the mounting, installation, commissioning, configuration, operation, troubleshooting and decommissioning of the product as well as the operation of the product user interface.

Observe all documentation that accompanies the product, keep them in a convenient place and available at all times.

Illustrations in this document are reduced to the essential information and may deviate from the real product.

1.2. Levels of Warning Messages

The following levels of warning messages may occur when handling the product

 **DANGER**

DANGER indicates a hazardous situation which, if not avoided, will result in death or serious injury.

 **WARNING**

WARNING indicates a hazardous situation which, if not avoided, could result in death or serious injury.

 **CAUTION**

CAUTION indicates a hazardous situation which, if not avoided, could result in minor or moderate injury.

 **NOTICE**

NOTICE indicates a situation which, if not avoided, can result in property damage.

INFORMATION provides tips which are valuable for the optimal installation and operation of the product.

2. Safety

2.1. Intended Use

The inverter, battery packs and the electricity meters make up a system for optimization of self-consumption for a household. The inverter can achieve bidirectional transfer between AC current and DC current. The battery pack is used for the energy storage.

The SMILE-G3 system is suitable for indoor and outdoor installation.

The SMILE-G3-INV must only be operated with PV arrays of protection class II in accordance with IEC 61730, application class A. The PV modules must be compatible with this product.

PV modules with a high capacity to ground must only be used if their coupling capacity does not exceed 1.0 μF .

All components must operate in a scenario suitable for their operation.

Be sure to use this product in accordance with the information provided in the accompanying documents and local applicable standards and directives. Any other operation may cause personal injury or property damage.

Alterations to the product, e.g. changes or modifications, are only permitted with the express written permission of AlphaESS. Unauthorized alterations will void guarantee and warranty claims. AlphaESS shall not be held liable for any damage caused by such changes.

Any use of the product other than that described in the Intended Use section does not qualify as appropriate.

The enclosed documentation is an integral part of this product. Keep the documentation in a convenient place for future reference and comply with all instructions contained therein.

The type label must remain permanently attached to the product.











2.2. Safety Instructions for Battery

2.2.1. General Safety Precautions













- Overvoltage or wrong wiring can damage the battery pack and cause deflagration, which can be extremely dangerous.
- All types of breakdown of the battery may lead to a leakage of electrolyte or flammable gas.
- Battery pack is not user-serviceable. There is high voltage in the device.
- Read the label with Warning Symbols and Precautions, which is on the right side of the battery pack.
- Do not connect any AC conductors or PV conductors directly to the battery pack which should be only connected to the inverter.
- Do not charge or discharge damaged battery.
- Do not damage the battery pack in such ways as dropping, deforming, impacting, cutting or penetrating with a sharp object. It may cause a leakage of electrolyte or fire.
- Do not expose battery to open flame.

2.3. Symbols explanation

Symbols on the type label of the inverter:

Symbol	Explanation
	Beware of a danger zone This symbol indicates that the product must be additionally grounded if additional grounding or equipotential bonding is required at the installation site.
	Beware of electrical voltage The product operates at high voltages.
	Beware of hot surface The product can get hot during operation.
	Danger to life due to high voltages in the inverter, observe a waiting time of 5 minutes. Prior to performing any work on the inverter, dis-connect it from all voltage sources as described in this document.
	WEEE designation Do not dispose of the product together with the household waste but in accordance with the disposal regulations for electronic waste applicable at the installation site.
	Observe the documentation
	CE marking The product complies with the requirements of the applicable EU directives.
	Certified safety The product is TUV-tested and complies with the requirements of the EU Equipment and Product Safety Act.
	RCM (Regulatory Compliance Mark) The product complies with the requirements of the applicable Australian standards.
	UKCA marking The product complies with the regulations of the applicable laws of England, Wales and Scotland.
	RoHS labeling The product complies with the requirements of the applicable EU directives.

Symbols on the type label and warning label of the battery pack.

Symbol	Explanation
	<p>Beware of a danger zone</p> <p>This symbol indicates that the battery pack must be additionally grounded if additional grounding or equipotential bonding is required at the installation site.</p>
	<p>Risk of chemical burns</p>
	<p>Risk of explosion</p>
	<p>Observe the documentation</p>
	<p>Risk of electrolyte leakage</p>
	<p>CE marking</p> <p>The product complies with the requirements of the applicable EU directives.</p>
	<p>Refer to the instruction for operation</p>
	<p>Use eye protection</p>
	<p>Fire, naked light and smoking prohibited</p>
	<p>No nearing</p>
	<p>Do not dispose of the battery pack together with the household waste but in accordance with the locally applicable disposal regulations for batteries</p>
	<p>Recycling code</p>
<p>UN38.3</p>	<p>Marking for transport of dangerous goods</p> <p>The product passes the certifications of the UN38.3</p>

3. Product Introduction and Application Scenarios

3.1. System introduction

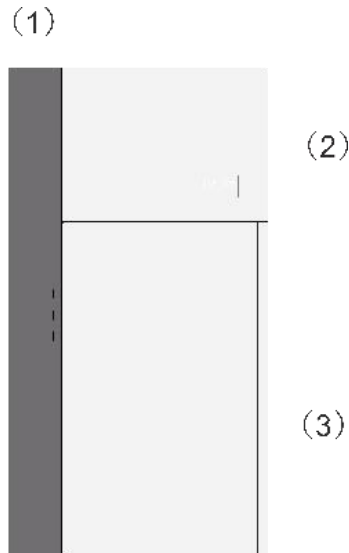

Dimension(W×H×D): 610×1168×230mm

Object	Name	Explain
1	Cable Cover	Cover for the left wiring area
2	Inverter	Inverter
3	Smile-G3-Bat-10.1P	Battery

3.2. Product Description

3.2.1. Inverter Display Interface Introduction

LED Display

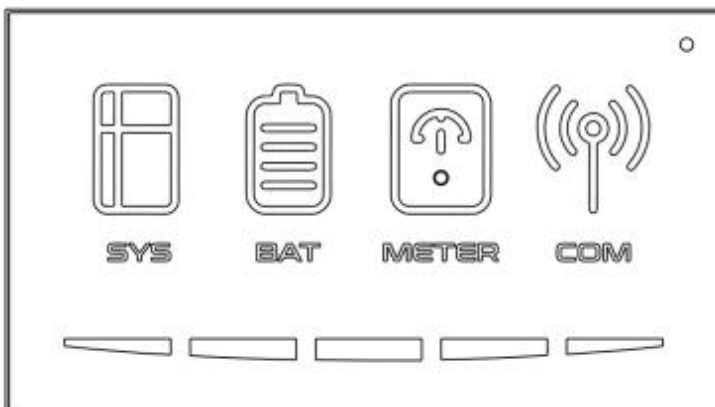



The three LED indicators on the front cover provide information about the SOC operational status of the battery with lights displaying solid white or flashing.

 : White LEDs flash

 : White LEDs on

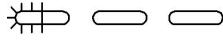
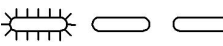
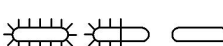
 : White LEDs off

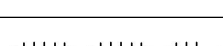
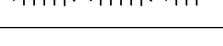
LED Indicator	No.	SOC	Description
LEDs show the SOC status	1		$SOC \leq 10\%$
	2		$10\% < SOC \leq 30\%$
	3		$30\% < SOC \leq 50\%$
	4		$50\% < SOC \leq 60\%$
	5		$60\% < SOC \leq 90\%$
	6		$90\% < SOC \leq 100\%$

3.3. Application Scenarios

AlphaESS SMILE-G3 system (includes inverter SMILE-G3-INV and battery SMILE-G3-BAT-10.1P) can be applied in DC-coupled systems (mostly new installation), AC-coupled systems (mostly retrofit), Hybrid-coupled systems (mostly retrofit, and increase the PV capacity), and Off-grid (with Generator) systems as the following schemes show :

3.3.1. DC-coupled Storage System

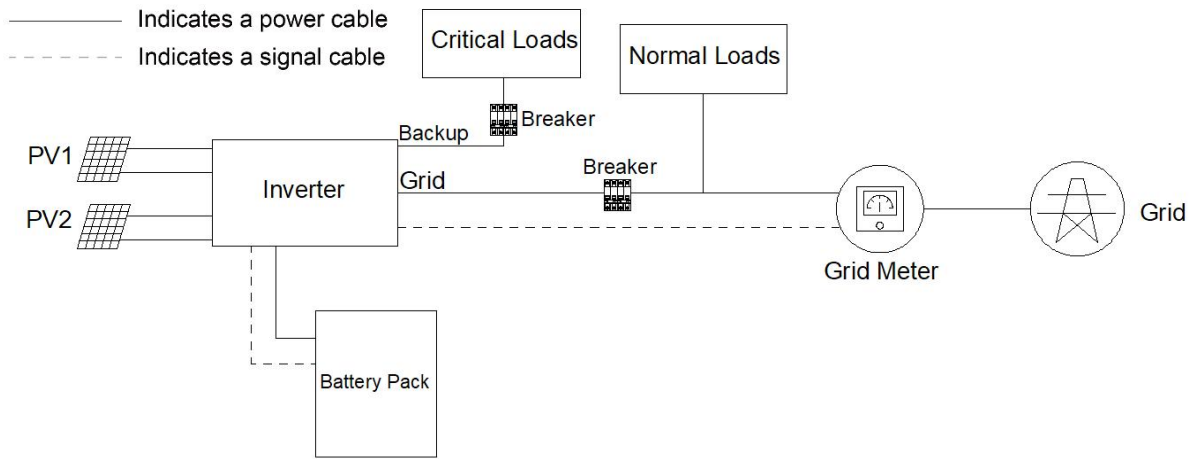

DC-coupled Storage System - Scheme

3.3.2. AC-coupled Storage System

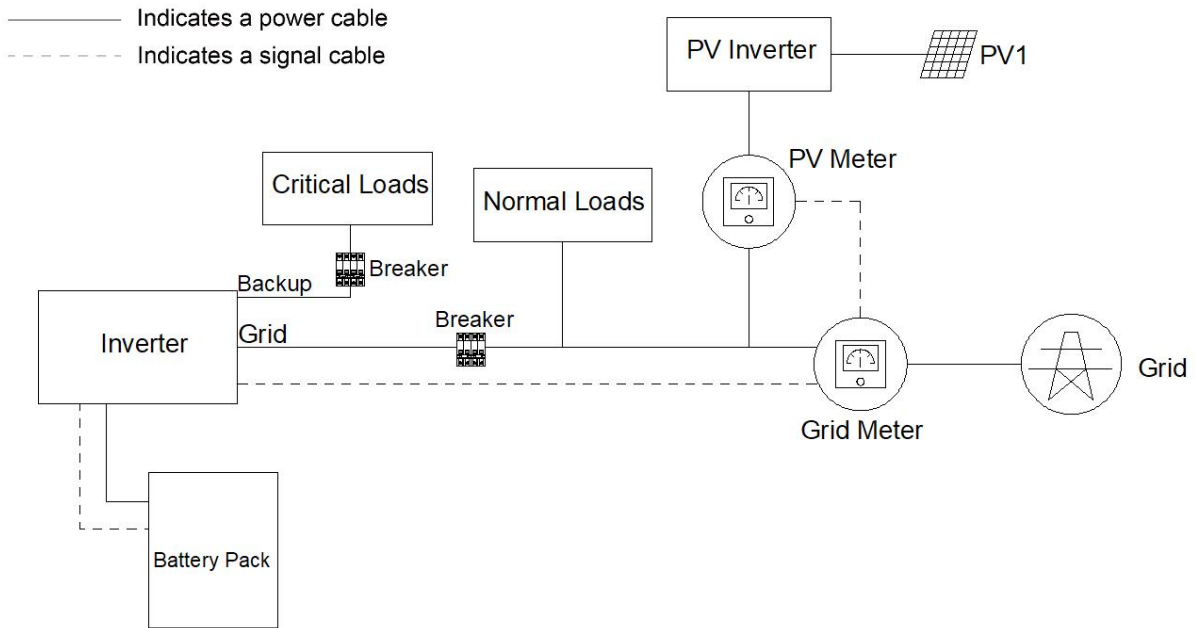

AC-coupled Storage System-Scheme

3.3.3. Hybrid-coupled Storage System

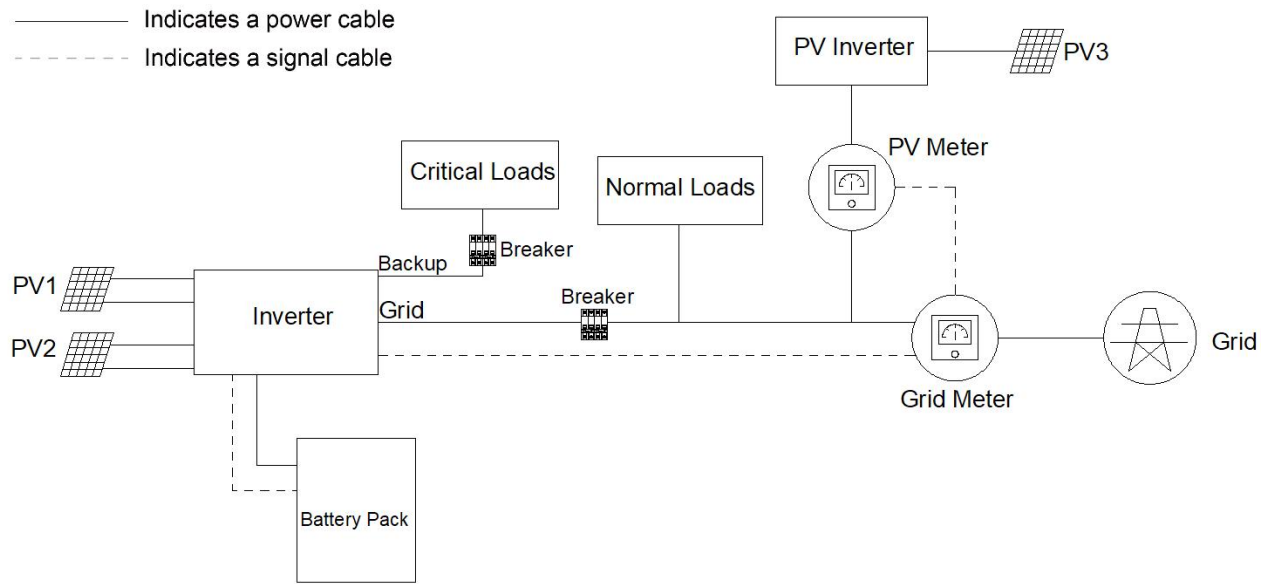

Hybrid-coupled Storage System - Scheme

4. Installer Account Register and Install New System

4.1. Register on APP

4.1.1. Download and Install the APP



4.1.2. Install New System

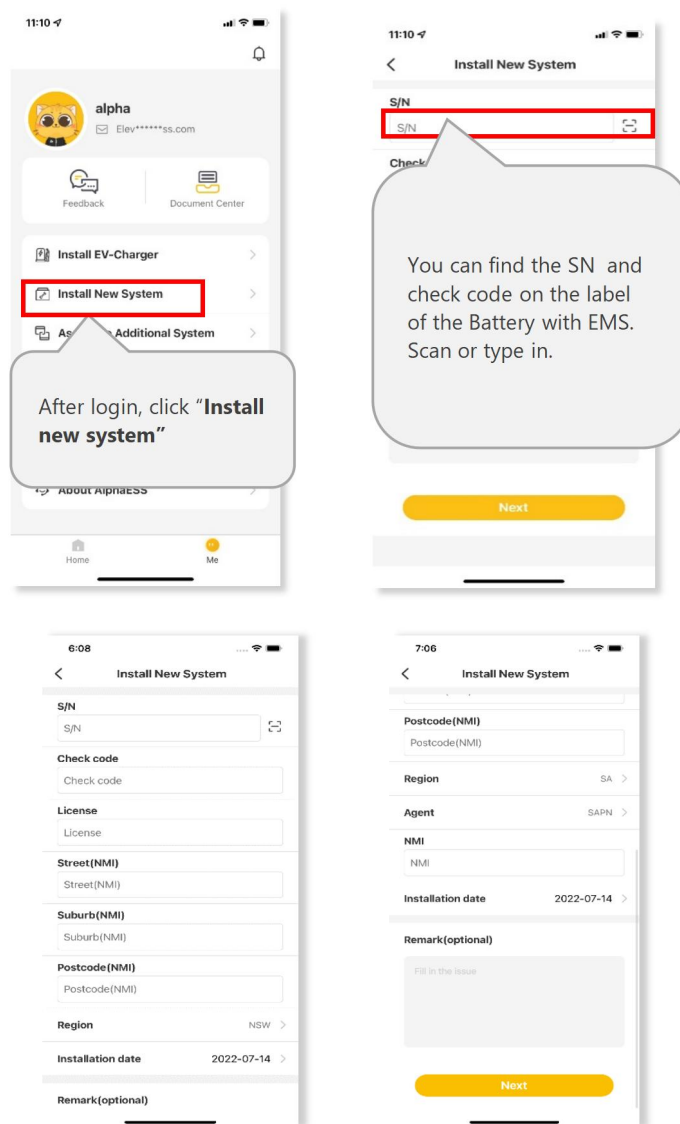

Australian Installer

Please enter your installer account and click install New system to bind the system to your account and set the system.

Enter S/N, check code, license, create time, customer full name, contact number, address, and click the save button. If you are an Australian installer, you will need to fill in the Street (NMI), Suburb (NMI) and Postcode (NMI) fields and add a new Region field, which has six fixed options (NSW, QLD, VIC, SA, TAS, WA). If SA is selected for Region, two more fields are added which are Agent and NMI. Fields that are not marked "optional" need to be filled in. Click "Next" to go to the installation steps interface.

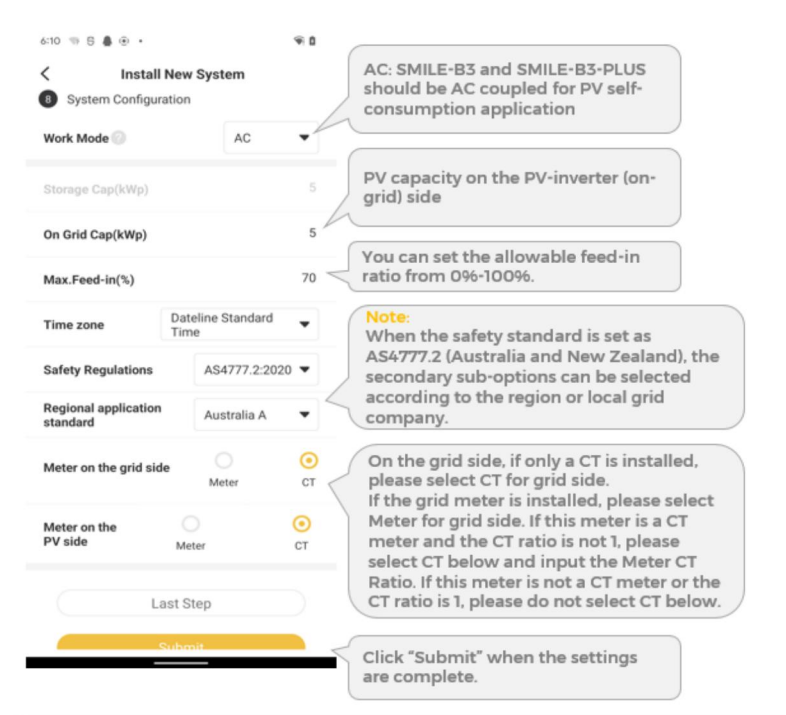
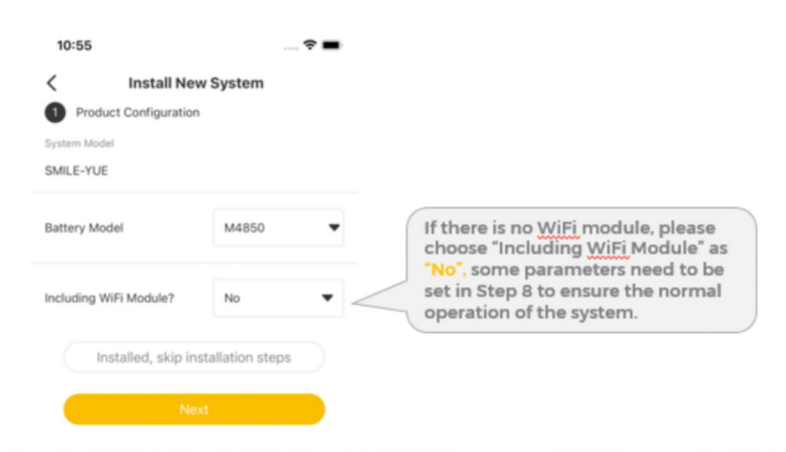

4.2. Register on AlphaCloud

4.2.1. Install New System

Installers who haven't yet registered need to click "Register" to visit the registration

page. Please refer to "AlphaCloud Online Monitoring Webserver Installers User Manual", which you can get from AlphaESS sales and get license number from relevant sales from Alpha ESS.

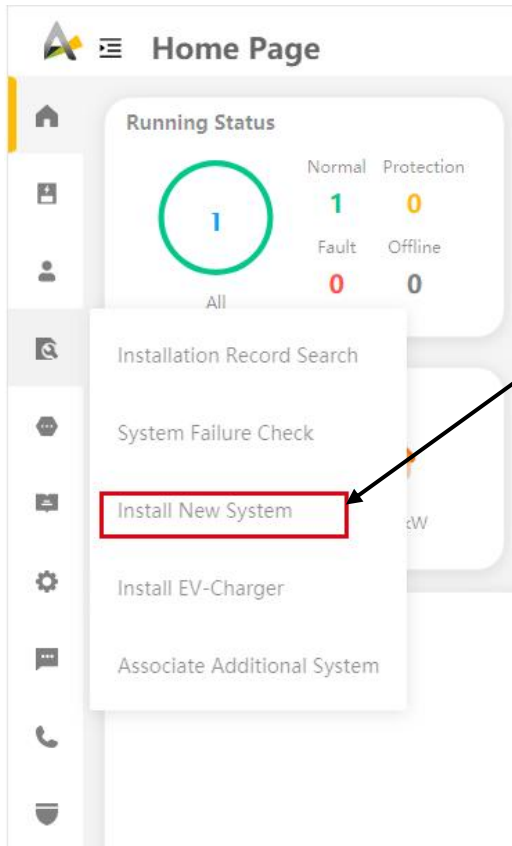

The screenshot shows the 'Home Page' of the AlphaESS webserver. The 'Running Status' section displays a green circle with the number '1' and a table of system statuses:

Normal	Protection
1	0
Fault	Offline
0	0

The sidebar menu on the left includes options like 'Installation Record Search', 'System Failure Check', 'Install New System' (highlighted with a red box), 'Install EV-Charger', and 'Associate Additional System'. A callout box with an arrow pointing to the 'Install New System' option contains the following text:

Log in to your installer account and choose Storage System Maintenance> "Install new system" to register new system at Alpha ESS.

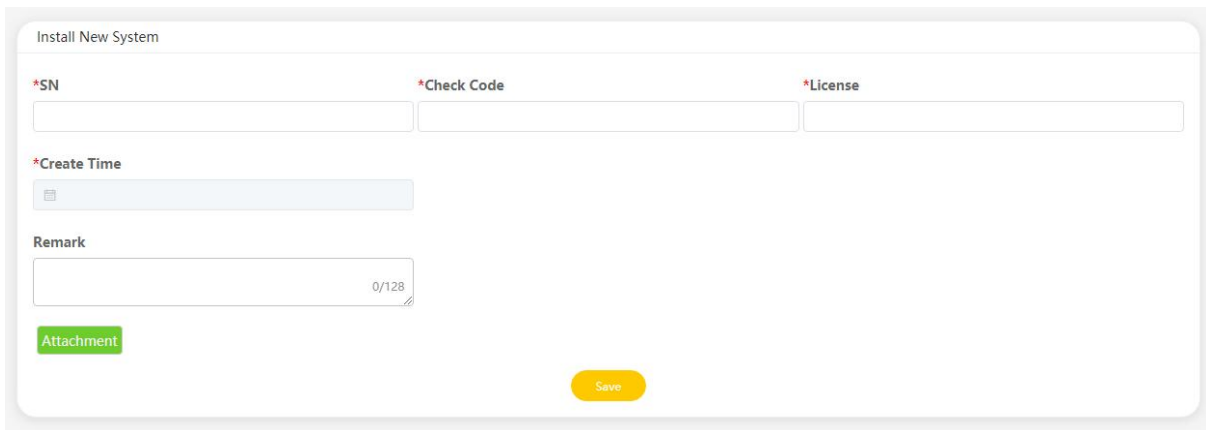

The 'Install New System' form contains the following fields and controls:

- *SN: Text input field
- *Check Code: Text input field
- *License: Text input field
- *Create Time: Date selection field
- Remark: Text area with a character count of 0/128
- Attachment: Green button
- Save: Yellow button

Enter the system S/N, check code, license, installation date and click the save button. The red * in front of it is required. Click the Browse button to select the attachment you want to add.

5. Powering On and Off the System

5.1. Powering on the System

- 1) Switch on the battery breaker of the batteries.
- 2) Switch on the battery breaker which is at the bottom of the SMILE-G3-INV.
- 3) Press the battery button, if there are more than one battery, the button for each battery should be pressed within 5s of the previous one.
- 4) Switch on the AC breaker between the grid port of the SMILE-G3-INV and the grid.
- 5) Switch on the AC breaker between the backup port of the SMILE-G3-INV and the loads.
- 6) Switch on the PV switch at the bottom of the SMILE-G3-INV if there is any.
- 7) Switch on the AC breaker (if there is any) between the PV-inverter and the grid.

5.2. Powering off the System



WARNING

After the energy storage system is powered off, the remaining electricity and heat may still cause electric shocks and body burns. Therefore, put on protective gloves and operate the product 5 minutes after the power-off.

Procedure

- 1) Switch off the AC breaker between the SMILE-G3-INV and the load.
- 2) Switch off the AC breaker between the SMILE-G3-INV and the grid.
- 3) Switch off the PV switch at the bottom of the SMILE-G3-INV if there is any.
- 4) Switch off the PV switch between the PV string and the SMILE-G3-INV if there is any.
- 5) Switch off the battery breaker which is at the bottom of the SMILE-G3-INV.
- 6) Long press 5s the power button of the battery.
- 7) Switch off the battery breaker of the battery.

6. Maintenance and Troubleshooting

6.1. Routine Maintenance

Normally, the energy storage system need no maintenance or calibration.

However, in order to maintain the accuracy of the SOC, it is recommended to perform a full charge calibration for SOC (charging battery until the charging power is 0) on the battery at regular intervals (such as two weeks).

Disconnect the system from all power sources before cleaning. Clean the housing, cover and display with a soft cloth.

To ensure that the energy storage system can operate properly in the long term, you are advised to perform routine maintenance on it as described in this chapter.

Maintenance checklist

Check Item	Acceptance Criteria	Maintenance Interval
Product cleanliness	The heatsink at the back of the product are free from obstacles or dust.	Once every 6 to 12 months
Product visible damage	The product are not damaged or deformed.	Once every 6 months
Product running status	<ol style="list-style-type: none"> 1. The product operate with no abnormal sound. 2. All parameters of the product are correctly set. Perform this check when the product is running. 	Once every 6 months
Electrical connections	<ol style="list-style-type: none"> 1. Cables are securely connected. 2. Cables are intact, and in particular, the cable jackets touching the metallic surface are not scratched. 3. Unused cable glands are blocked by rubber sealing which are secured by pressure caps. 	<p>Perform the first maintenance 6 months after the initial commissioning.</p> <p>From then on, perform the maintenance once every 6 to 12 months.</p>

 **CAUTION**

Risk of burns due to hot heatsink and housing

The heatsink and housing of the inverter can get hot during operation.

- During operation, do not touch any parts other than the cover.
- Wait approx. 30 minutes before cleaning until the heatsink has cooled down.

6.2. Troubleshooting

Inverter Error Troubleshooting

Error No.	Error description	Solution
100000	Grid_OVP	1. Check whether Grid is abnormal. 2. Confirm whether the grid cable connection is normal. 3. Restart inverter and check whether the fault is existing.
100001	Grid_UVP	
100002	Grid_OFP	
100003	Grid_UFP	
100005	BUS_OVP1	1. Check whether the input voltage of PV1 and PV2 ex-ceeds 580V. 2. If the first one does not exist, restart the inverter to see if the fault still exists. If it still exists, please call the service center.
100007	Insulation_fault	1. Check whether PV cable connection is reliable. 2. Check whether PV cable is damaged.
100008	GFCI_fault	1. Restart inverter and check whether the

100009	Leakage current test failure	fault is existing.
100010	Grid_relay_fault	
100011	Over_Temperature	<ol style="list-style-type: none"> 1. Check whether the environment around inverter is with poor heat dissipation. 2. Confirm whether inverter installation meet the installation requirements.
100014	M_S_com_fault	Restart the inverter and check whether the fault is existing.
100017	MPPT1_OVP	Check the PV1 voltage. If it exceeds 585VDC, reduce the number of PV modules.
100018	MPPT1_SW_OCP	<ol style="list-style-type: none"> 1. Try to reduce the PV power.
100019	MPPT1_HW_OCP	<ol style="list-style-type: none"> 2. Restart the inverter to see if the fault still exists. If it still exists, please call the service center.
100020	MPPT1_OTP	<ol style="list-style-type: none"> 1. Try to lower the ambient temperature. 2. Make sure that the inverter is installed according to the manual and there is no shelter around the inverter. 3. After the inverter is powered off and waiting for 30 minutes, then restart it. If the fault still exists, please call the service center.
100021	MPPT2_OVP	Check the PV2 voltage. If it exceeds 585V, reduce the number of PV modules
100022	MPPT2_SW_OCP	<ol style="list-style-type: none"> 1. Try to reduce the PV power.
100023	MPPT2_HW_OCP	<ol style="list-style-type: none"> 2. Restart the inverter to see if the fault still exists. If it still exists, please call the service center.







100024	MPPT2_OTP	<ol style="list-style-type: none"> 1. Try to lower the ambient temperature. 2. Make sure that the inverter is installed according to the manual and there is no shelter around the inverter. 3. After the inverter is powered off and waiting for 30 minutes, then restart it. If the fault still exists, please call the service center.
100025	BAT_OVP	Check whether the actual battery voltage exceeds the battery charging cut-off voltage by more than 20V.
100026	BAT_UVP	Check whether the actual battery voltage is lower than the battery discharge cut-off voltage.
100027	Battery_lose	Confirm that the wiring is normal, and check whether the battery voltage sampling value is less than 75V.
100028	BAT_OTP	<ol style="list-style-type: none"> 1. Try to lower the ambient temperature. 2. Make sure that the inverter is installed according to the manual and there is no shelter around the inverter. 3. After the inverter is powered off and waiting for 30 minutes, then restart it. If the fault still exists, please call the service center.
100029	BAT1_charge_OCP	<ol style="list-style-type: none"> 1. Try to reduce battery power. 2. Restart the inverter to see if the fault still exists. If it still exists, please call the service center.
100030	BAT1_discharge_OCP	
100031	BAT2_charge_OCP	
100032	BAT2_discharge_OCP	
100033	BAT1_HW_OCP	



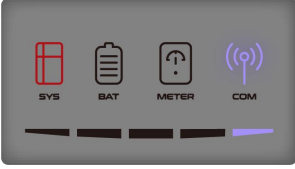

100034	BAT2_HW_OCP	
100035	INV_OTP	<ol style="list-style-type: none"> 1. Try to lower the ambient temperature. 2. Make sure that the inverter is installed according to the manual and there is no shelter around the inverter. 3. After the inverter is powered off and waiting for 30 minutes, then restart it. If the fault still exists, please call the service center.
100036	NV_OVP	The effective value of grid voltage exceeds the maximum protection value of national standard voltage.
100037	INV_UVP	<ol style="list-style-type: none"> 1. Whether the off grid output terminal is short circuited or has impact load. 2. Restart the inverter to see if the fault still exists. If it still exists, please call the service center.
100038	Output_DC_over_current	Restart the inverter to see if the fault still exists. If it still exists, please call the service center.
100039	INV_OCP	<ol style="list-style-type: none"> 1. Check whether the off grid output terminal is overloaded, short circuited or has impact load. 2. Restart the inverter to see if the fault still exists. If it still exists, please call the service center.
100040	INV_HW_OCP	Restart the inverter to see if the fault still exists. If it still exists, please call the service center.
100041	Output_DC_over_voltage	
100042	Output_short	1. Use a multimeter to test the impedance of the off grid output. If it is small, check

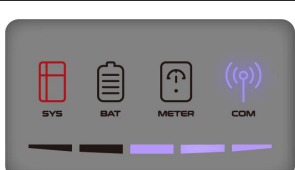
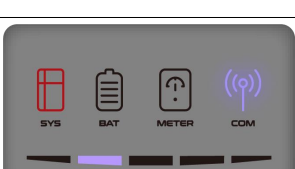

2		<p>whether the wiring is correct.</p> <p>2.Restart the inverter to see if the fault still exists. If it still exists, please call the service center.</p>
10004 3	Output_overload	<p>1. Check whether the load exceeds the rated power.</p> <p>2. Restart the inverter to see if the fault still exists. If it still exists, please call the service center.</p>
11000 0	Bat over-voltage alarm	<p>Check that the actual battery voltage is 10V higher than the battery charging cut-off voltage</p>
11000 1	Bat under-voltage alarm	<p>Check that the actual battery voltage is 10V higher than the battery discharging cut-off voltage</p>
11000 2	output_overload_alarm	<p>Check whether the load exceeds 0.95 of the rated power</p>
11000 3	abnormal_temperature_sensor	<p>Restart the inverter to see if the fault still exists. If it still exists, please call the service center.</p>
11000 4	dc_power_alarm	<p>1. Check whether the total power of the battery and PV is less than the load power.</p> <p>2. Restart the inverter to see if the fault still exists. If it still exists, please call the service center.</p>
11000 5	battery_stops_running_alarm	<p>1. If the battery is not connected, use a multimeter to measure whether there is voltage at the battery terminal.</p> <p>2. Restart the inverter to see if the fault still exists. If it still exists, please call the service center.</p>

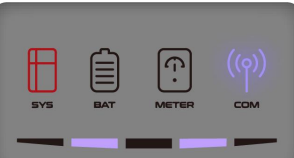
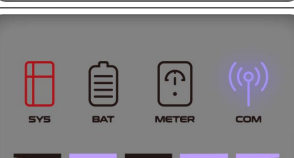
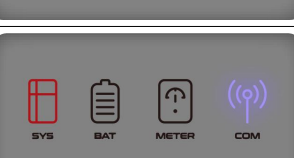
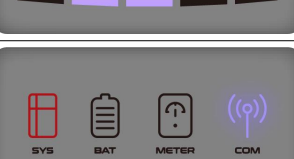
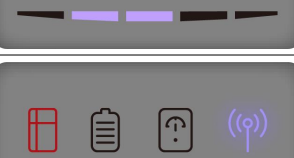
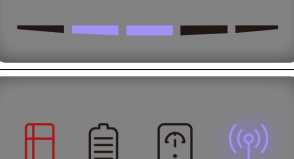

11000 6	overtempera- ture_alarm	<ol style="list-style-type: none">1. Try to lower the ambient temperature.2. Make sure that the inverter is installed according to the manual and there is no shelter around the machine.3. After the inverter is powered off and waiting for 30 minutes, then restart it. If the fault still exists, please call the service center.
------------	----------------------------	---

6.2.1. Inverter Protection Description

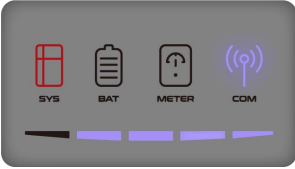
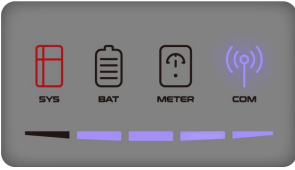
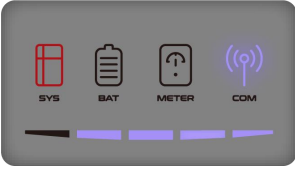
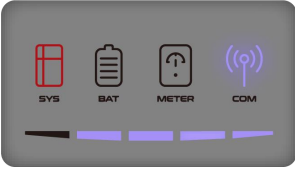
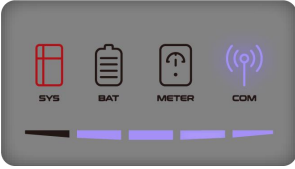
LED Indicator	Error Code	LED Display	Description	Troubleshooting
Inverter is faulty, SYS red light is on, BAT is off, METER is off, COM is on	1		DC-Group: Bus soft start failed	Wait for automatical recovery. If the problem is not solved yet, please call the service center.
	2		BUS_OVP1	
	2		Dc_bus_under volt	
	3		Bus Short	
	4		INV Soft Timeout	
	5		INV_OVP	
	6		Output_short	
	7		Output_overload	Wait for automatical recovery. If the problem is not solved yet, please call the service center.
8		Grid Load Reverse		

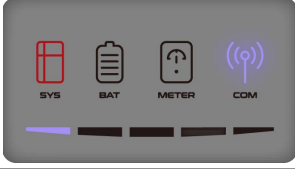
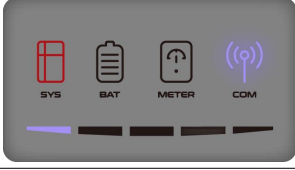
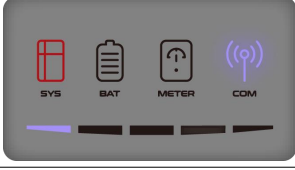
Inverter is faulty, SYS red light is on, BAT is off, METER is off, COM is on	8		LPE Reverse	
	9		EMSSCI	
	10		12V auxiliary power Fault	
	10		1.5V auxiliary power Fault	
	10		0.5V auxiliary power Fault	
	11		NTC Loss	
	12		BAT_UVP	
	12		BAT_OVP	
	13		Leakage current test failure	
	14		GFCI_fault	
				Wait for automatic recovery. If the problem is not solved yet, please call the service center.

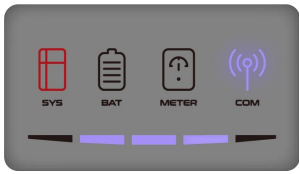
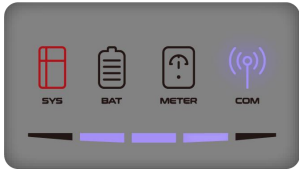
<p>Inverter is faulty, SYS red light is on, BAT is off, METER is off, COM is on</p>	15		INV HCT Fault	<p>Wait for automatic recovery. If the problem is not solved yet, please call the service center.</p>
	15		Load CT Fault	
	15		PV1 CT Fault	
	15		PV2 CT Fault	
	15		Bat1 CT Fault	
	15		Bat2 CT Fault	
	16		Grid_relay_fault	
	16		Bypass Relay Fault	
	16		Load Relay Fault	
	16		NPE Relay Fault	

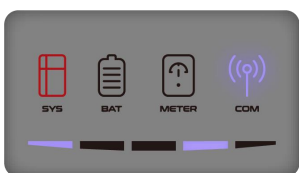
Inverter is faulty, SYS red light is on, BAT is off, METER is off, COM is on	14		Insulation_fault	Wait for automatic recovery. If the problem is not solved yet, please call the service center.
	14		DCI Consistency Failure	
	17		WatchDog	
	18		INV Open Loop	

 **NOTE**

1. the four LEDs in the first row are system (SYS), battery (BAT), meter (METER), and communication (COM);
2. The five LEDs in the second row are divided into two functions:
 - 1) Battery SOC power display;
 - 2) When a fault occurs, the corresponding fault code will be displayed. From right to left, the numbers represented by each light are 1, 2, 4, 8, 16.

6.2.2. Battery Protection Description









LED Indicator	Error Code	LED Display	Description	Troubleshooting
Yellow LEDs on or Yellow LEDs flash once per second.	1		Temperature difference	Wait for automatic recovery. If the problem is not solved yet, please call the service center.
	3		High-Temperature	Stop discharging and charging until this code is eliminated and wait for the temperature to drop.
	4		Low-temperature discharge	Stop discharging until this code is eliminated and wait for the temperature to rise
	5		Over-current charge	Wait for automatic recovery. If the problem is not solved yet, please call the service center.
	6		Over-current discharge	
	8		Cell overvoltage	
	9		Cell undervoltage	Stop discharging and call the service immediately.
	11		Low-temperature charge	Stop discharging until this code is eliminated and wait for the temperature to rise.



NOTE

In the case of work mode, if the protection code 9 appears, please press the power

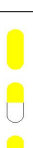
button of the battery 5 times within 10 seconds, the BMS will be forced to turn on the MOSFET of discharge so that the inverter can detect the battery open voltage and charge the battery.

6.2.3. Battery Error Description

LED Indicator	Error Code	LED Display	Description	Troubleshooting
Yellow LEDs on or Yellow LEDs flash once per second.	Error 01		Hardware error	Wait for automatic recovery. If the problem is not solved yet, please call the service center.
	Error 05		Hardware error	
	Error 06		Circuit breaker open	Switch on circuit breaker after powering off the battery.
	Error 08		LMU disconnect (slave)	Reconnect the BMS communication cable.
	Error 09		SN missing	Call for service.
	Error 10		LMU Disconnect (master)	Reconnect the BMS communication cable.
	Error 11		Software version inconsistent	Call for service.
	Error 12		Multi master	Restart all batteries.

	Error 13		MOS over temperature	Power off the battery and power on the battery after 30minutes.
	Error 14		Insulation fault	Restart battery and in case the problem is not resolved, call for service.
	Error 15		Total voltagefault	Restart battery and in case the problem is not resolved, call for service.

 **NOTE**

In the case of work mode, if the protection code 09 appears, please press the power button 5times within 10 seconds, the BMS will be forced to turn on the MOSFET of discharge so thatthe inverter can detect the battery open voltage and charge the battery.

7. Uninstallation & Return

7.1. Removing the Product

Procedure

- Step 1: Power off the energy storage system by following instructions in Chapter 8.2 Powering Off the System.
- Step 2: Disconnect all cables from the product, including communication cables, PV power cables, battery power cables, AC cables, and PE cables.
- Step 3: Remove the WiFi module.
- Step 4: Remove the product from the wall bracket. Remove the expansion battery from the wall bracket.
- Step 5: Remove the wall brackets.

7.2. Packing the Product

If the original packaging is available, put the product inside it and then seal it using adhesive tape.

If the original packaging is not available, put the product inside a suitable cardboard box and seal it properly.

7.3. Disposing of the Product

- If the product service life expires, dispose of it according to the local disposal rules for electrical equipment and electronic component waste.
- Dispose of the packaging and replaced parts according to the rules at the installation site where the device is installed.
- Do not dispose the product with normal domestic waste.



8. Specification

8.1. Datasheet of Inverter SMILE-G3-INV

Item	SMILE-G3-S5-INV	SMILE-G3-S3.6-INV	SMILE-G3-B5-INV
Input DC (PV side)			
Recommended max. PV power	10000	7200	NA
Max. PV input voltage	580 V		NA
Rated voltage	360 V		NA
Start-up voltage	90 V		NA
MPPT voltage range	100 ~ 550 V		NA
Max. Input Current Per MPPT	15 A / 15 A		NA
Max. Short Circuit Current Per MPPT	18.75 A / 18.75 A		NA
MPPT Number	2		NA
Max Input Strings Number Per MPPT	1		NA
Battery			
Battery Type	Li-ion		
Battery Voltage Range	80 ~ 450 V		
Maximum Charging Power	5 kW		
Maximum Charge/ discharge current	60 A / 60 A		
Communication	CAN		

Output AC (Back-up)			
Rated output power	5 kW	3.68 kW	5 kW
Max Apparent Output Power	5 kVA	3.68 kVA	5 kVA
Back-up switch time	<20 ms		
Rated output voltage	L/N/PE, 230 V		
Rated Frequency	50/60 Hz		
Rated output current	21.7 A	15.7 A	21.7 A
THDv(@linear load)	3%		
Input AC (Grid side)			
Rated Output Current	L/N/PE, 230 V		
Rated Frequency	50/60 Hz		
Rated Input Power	10 kW	7.2kW	10 kW
Max. input current	43.5 A	31.3A	43.5 A
Output AC(Grid side)			
Rated output power	5 kW	3.68 kW	5 kW
Max. Apparent Output Power	5 kVA	3.68 kVA	5 kVA
Operation Phase	Single phase		
Rated Grid Voltage	L/N/PE, 230 V		
Grid Voltage	180 ~ 270 V		

Range			
Rated Grid Frequency	50 / 60 Hz		
Rating Grid Output Current	21.7 A	15.7 A	21.7 A
Power Factor	>0.99 (0.8 leading - 0.8 lagging)		
Thdi	< 3%		
Protection Class	I		
Oversvoltage Category	III		
Efficiency			
Max Efficiency	>97%		
EU Efficiency	>96.2%		
Protection			
Anti-Islanding Protection	Integrated		
Insulation Resistor Detection	Integrated		
Residual Current Monitoring Unit	Integrated		
Output Over Current Protection	Integrated		
Output Short Protection	Integrated		
Output Oversvoltage Protection	Integrated		
DC Reverse Polarity Protection	Integrated		

PV Overvoltage Protection	Integrated
PV Switch	Integrated
Battery Breaker	Integrated
General data	
Dimensions (W*H*D)	610*212*366 mm
Weight	19.5kg
Topology	Transformerless
Operation Temperature Range	-25 ~ +60 °C
Ingress Protection	IP65
Noise Emission	<30 dB(A) @1m
Cooling Concept	Natural convection
Max. Operation Altitude	3000 m
Grid Connection Standard	G98/G99, VDE-AR-N 4105, EN 50549-1, VDE 0126, RD 1699, CEI0-21, C10/11, NRS 097-2-1, Tor Erzeuger, MEA, PEA, AS/NZW 4777.2, IEEE1547
Safety/ EMC Standard	IEC62040-1, IEC62109-1/-2, AS3100, NB/T 32004, EN61000-6-2, EN61000-6-3
Features	
PV Connection	Vaconn H4 connectors/MC4 (optional)
Grid Connection	Vaconn
Back-up Connection	connectors
BAT Connection	connectors

Communication	LAN, WiFi (optional)
Warranty	5 years standard

8.2. Datasheet of Battery

Model	SMILE-G3-BAT-10.1P
Battery type	LFP (LiFePO4)
Weight	90 kg
Dimension (W*D*H)	610 * 210 * 790 mm
Ingress protection	IP65
Energy capacity	10.1 kWh
Usable capacity	9.6 kWh
DoD	95%
Nominal voltage	96 V
Operating voltage range	90 ~ 108 V
Max. Charging / discharging current *	60 A
Operating temperature range	Charge: $0 < T < 50^{\circ}\text{C}$ / Discharge: $-10 < T < 50^{\circ}\text{C}$
Monitoring parameters	System voltage, current, cell voltage, cell temperature, PCBA temperature
BMS communication	CAN
System	
Safety	IEC62619/ IEC63056/IEC62040
Warranty	5 Year product warranty, 10 Year performance warranty
Transportation	UN38.3

* Max. charge/discharge current derating will occur related to temperature and SOC.

8.3. Safety Data Sheet

SECTION 1. IDENTIFICATION

Product Identifier

Product Name: Rechargeable Lithium-ion Battery

Models: SMILE-G3-BAT-10.1P, SMILE-G3-BAT-10.1P II
 SMILE-G3-BAT-10.1P III, SMILE-G3-BAT-10.1P IV
 SMILE-G3-BAT-10.1P V, SMILE-G3-BAT-10.1P VI

Other Means of Identification

SDS #: SDS023

Synonyms: Lithium Iron Phosphate (LiFePO₄, LFP)

Proper Shipping Name (ADG Code): Lithium-ion Battery

UN/ID No: UN3480

Recommended Use Energy Storage; Battery Packs

Details of Manufacturer or Importer Alpha ESS Australia Pty., Ltd.
 530 Botany Rd,
 Beaconsfield
 Sydney, 2015
 Australia

Emergency Phone Number 1300 968 933(Australia)

SECTION 2. HAZARDS IDENTIFICATION

Classification of the hazardous chemical

EXEMPT FROM HAZARD CLASSES AND CATEGORIES ACCORDING TO AUSTRALIAN GHS.

Label elements, including precautionary statements

No signal word, pictograms, hazard or precautionary statements have been allocated according to GHS.

But there is other label for Transport of Dangerous Goods on package.



Other hazards

This product is a Lithium Iron Phosphate Battery with certified compliance under the UN Recommendations on Transport of Dangerous Goods, Manual of Tests and Criteria, Part III, sub-section 38.3. For the battery cell, chemical materials are stored in a hermetically sealed metal case, designed to withstand temperatures and pressures encountered during normal use. As a result, during normal use, there is no physical danger of ignition or explosion and chemical danger of hazardous materials' leakage. However, if exposed to a fire, added mechanical shocks, decomposed, added electric stress by misuse, the gas release vent will be operated. The battery cell case will be breached at the extreme. Hazardous materials may be released. Moreover, if heated strongly by the surrounding fire, acrid or harmful fume may be emitted.

SECTION 3. COMPOSITION & INFORMATION ON INGREDIENTS

Chemical Name	CAS No	Weight [%]
SPCC-Fe	7439-89-6	20-25
Lithium Iron Phosphate (Lifepo4)	15365-14-7	18-20
Iron	7439-89-6	13-16
Lithium Hexafluorophosphate	21324-40-3	10-12
Copper Metal	7440-50-8	8-12
Carbon	7440-44-0	5-8
Aluminum Metal	7429-90-5	3-7
Polyester Resin	63148-65-2	3-5
Acrylonitrile-butadiene-styrene (ABS)	9003-56-9	1-3
Polyvinylidene Fluoride	24937-79-9	1-3
Polycarbonate	25037-45-0	1-3
Nickel	7440-02-0	0-1

SECTION 4. FIRST AID MEASURES

Description of necessary first aid measures

Eye Contact Rinse eyes with flowing water for 15 minutes and seek medical attention.

Skin Contact Wash the affected area thoroughly with soap and water for 15 minutes and seek medical attention.

Inhalation If internal contents are inhaled, evacuate the contaminated area, and seek medical attention.

Ingestion If ingestion of internal contents occurs, rinse mouth thoroughly with water. DO NOT INDUCE VOMITING. If vomiting occurs naturally, have victim lean forward to reduce risk of aspiration and continue to rinse mouth with water. Seek medical attention immediately.

Symptoms caused by exposure

Symptoms Adverse effects not expected from this product. Exposure to battery contents may cause irritation and potential burns.

Medical attention and special treatment

Notes to Physician Treat symptomatically.

SECTION 5. FIRE-FIGHTING MEASURES

Suitable extinguishing media

In case of fire suitable extinguishing media: carbon dioxide or dry chemical.

Use Novec 1230, FM-200, or dioxide extinguisher.

ABC extinguishers are not effective when the battery pack is on fire

Special hazards arising from chemical

Contents react with water. May explode if exposed to high temperatures due to pressure build up in battery casing. Lithium may burn in a fire situation and may be ejected from the battery. Damaged cells may evolve toxic and flammable vapours.

Specific protective equipment and precautions for firefighters

Evacuate area and contact emergency services. Toxic gases may be evolved in a fire situation. Remain upwind and notify those downwind of hazard. Wear full protective equipment including Self Contained Breathing Apparatus (SCBA) and protective gear in compliance with the Directive on Personal Protective Equipment 89/686/EEC when combating fire. Use water fog to cool intact containers and nearby storage areas.

Hazchem code

4 Dry Agent (water MUST NOT be allowed to come into contact with substance).

W Risk of violent reaction or explosion. Wear liquid-tight chemical protective clothing and breathing apparatus. Contain spill and run-off.

SECTION 6. ACCIDENTAL RELEASE MEASURES

Personal precautions, protective equipment and emergency procedures

Wear Personal Protective Equipment (PPE) as detailed in SECTION 8 of this SDS.

Environmental precautions

See SECTION 12 for additional Ecological Information.

Methods and materials for containment and cleaning up

If spilt, collect and reuse where possible. If battery is broken or damaged, absorb liquid with sand or similar. Contain spillage, then collect and place in suitable containers for disposal.

CAUTION: Avoid exposure to contents.

For waste disposal, see SECTION 13 of the SDS.

SECTION 7. HANDLING AND STORAGE

Precautions for safe handling

Before use carefully read the product manuals Use of safe work practices are recommended to avoid eye or skin contact and inhalation. Observe good personal hygiene, including washing hands before eating. Prohibit eating, drinking and smoking in contaminated areas.

Conditions for safe storage, including any incompatibilities

Store tightly sealed in a cool, dry, well ventilated area, removed from water, incompatible substances, heat or ignition sources and foodstuffs. Ensure containers are adequately labelled, protected from physical damage and sealed when not in use. Check regularly for leaks or spills. Store within the recommended limit of -20°C to 45°C. Do not expose to high temperature (55°C). Since short circuit can cause burn hazard or safety vent to open, do not store with metal jewelry, metal covered tables, or metal belt.

SECTION 8. EXPOSURE CONTROLS / PERSONAL PROTECTION

Exposure control measures

This product presents no health hazards to the user when used according to label directions for its intended purposes.

Biological monitoring

Ingredient	Determinant	Sampling Time	BEI
Polyvinylidene Fluoride	Fluoride in urine	Prior to shift	2 mg/L
	Fluoride in urine	End of shift	3 mg/L

Reference: ACGIH Biological Exposure Indices

Control banding

Control banding is not used.

Engineering controls

Use local exhaust ventilation or other engineering controls to control sources of dust, mist, fume and vapor.

Personal protective equipment (PPE):

Eye Protection: Not necessary under normal use. Wear safety goggles if handling a ruptured or leaking battery cell.

Skin Protection: Not necessary under normal use for hands and body. Wear PVC or rubber gloves if handling a ruptured or leaking battery cell.

Respiratory Protection: Not necessary under normal use. In case of battery or cell rupture, use a self-contained full face respiratory mask.

SECTION 9. PHYSICAL AND CHEMICAL PROPERTIES

Appearance:	Battery	Physical state:	Solid
Color:	Not Determined	Ph:	Not Determined
Odour type:	Odorless	Odour threshold:	Not Determined
Melting point:	Not Determined	Freezing point:	Not Determined
Boiling point:	Not Determined	Boiling range:	Not Determined
Flash point	Not Determined	Evaporative rate:	Not Determined
Flammability:	Not Determined	Flammability/explosive limits:	Not Determined
Oxidizing properties:	Not Determined	Viscosity:	Not Determined
Relative density:	Not Determined	Auto-ignition Temperature	Not Determined
Solubility in Water:	Insoluble	Partition coefficient: n-octanol /water	Not Determined
Water/ oil distribution coefficient:	Not Determined	Vapor pressure	Not Determined
Decomposition temperature:	Not Determined	Vapor density: (air = 1)	Not Determined
Saturated vapor concentration	Not Determined	Specific heat value	Not Determined
Particle size	Not Determined	Release of invisible flammable vapors and gases	Not Determined
Size distribution	Not Determined	Shape and aspect ratio	Not Determined
Crystallinity	Not Determined	Dustiness	Not Determined

Surface area	1.35 m ²	Degree of aggregation or agglomeration, and dispersibility	Not Determined
Redox potential	Not Determined	Biodurability or biopersistence	Not Determined
Surface coating or chemistry	Polyester Resin		

SECTION 10. STABILITY AND REACTIVITY

Reactivity:

Not Available

Chemical Stability:

Stable under normal use.

Possibility of hazardous reactions:

Polymerization will not occur.

Conditions to avoid:

Heat above 70°C or incinerate. Deform. Mutilate. Crush. Pierce. Disassemble. Recharge. Short circuit. Expose over a long period to humid conditions.

Incompatible materials:

Battery contents are incompatible with water (evolving flammable gas), oxidizing agents (e.g. hypochlorites), acids (e.g. nitric acid), alkalis (e.g. sodium hydroxide), heat and ignition sources.

Hazardous decomposition products:

May evolve hydrogen and lithium oxides when heated to decomposition.

SECTION 11. TOXICOLOGICAL INFORMATION

Information on likely routes of exposure

Acute toxicity

Information available for the product:

No specific acute toxicity data exists for this product. Batteries consist of a hermetically sealed metallic container containing a number of chemicals and materials of construction that may be hazardous upon release. Over exposure considered unlikely unless battery ruptures and contact with contents occurs. Contents may be harmful.

Inhalation: Toxicity data and effects of inhalation exposure are not available. Not a likely route of exposure under normal use.

Ingestion: Toxicity data and effects of ingestion exposure are not available. Not a likely route of exposure under normal use.

Skin Contact: Toxicity data and effects of skin contact exposure are not available. Not a likely route of exposure under normal use.

Eye Contact: Toxicity data and effects of eye contact exposure are not available. Not a likely route of exposure under normal use.

Component information

Chemical Name	Oral LD50	Dermal LD50	Inhalation LC50
Carbon 7440-44-0	> 8000 mg/kg (rat)	-	-

Early onset symptoms and delayed health effect from exposure

Please see SECTION 4 of this SDS for symptoms.

Numerical Measures of Toxicity

Not determined

SECTION 12. ECOLOGICAL INFORMATION

Ecotoxicity

The product is not classified as environmentally hazardous. However, this does not exclude the possibility that large or frequent spills can have a harmful or damaging effect on the environment.

Persistence and degradability

Not determined.

Bioaccumulative potential

Not determined.

Mobility in soil

Not determined.

Other adverse effects:

Not determined.

SECTION 13. DISPOSAL CONSIDERATIONS

Disposal Methods

Disposal of Wastes

Recycling is encouraged. Do NOT dump into sewage or water bodies. Dispose of in accordance with local, state and federal laws and regulations.

Contaminated Packaging

Disposal should be in accordance with applicable regional, national and local laws and regulations.

SECTION 14. TRANSPORT INFORMATION

URE Product listed in Section 1 is designed to comply with standard international shipping regulations including the UN Recommendations on the Transport of Dangerous Good; the IATA Dangerous Goods Regulations and the International Maritime Dangerous Goods Code.



	LAND TRANSPORT (ADG)	SEA TRANSPORT (IMDG / IMO)	AIR TRANSPORT (IATA / ICAO)
UN Number	3480	3480	3480
Proper Shipping Name	Lithium-ion Battery	Lithium-ion Battery	Lithium-ion Battery
Transport Hazard Class	9	9	9
Packing Group	II	II	II

Environmental hazards for transport purposes

No information provided

Special precautions for user

No information provided

Additional information

No information provided

Hazchem or Emergency Action Code

4W

SECTION 15. REGULATORY INFORMATION

Safety, health and environmental regulations

Poison schedule

A poison schedule number has not been allocated to this product using the criteria in the Standard for the Uniform Scheduling of Medicines and Poisons (SUSMP).

Classifications

Safework Australia criteria is based on the Globally Harmonised System (GHS) of Classification and Labelling of Chemicals.

The classifications and phrases listed below are based on the Approved Criteria for Classifying Hazardous Substances [NOHSC: 1008(2004)].

Hazard codes

None allocated.

Risk phrases

None allocated.

Safety phrases

None allocated.

Inventory listing(s)





AUSTRALIA: AICS (Australian Inventory of Chemical Substances)

All components are listed on AICS, or are exempt.

SECTION 16. OTHER INFORMATION

Original Preparation Date:	19 Apr 2022
Document Number:	VPM_SDS023
Document Title:	SMILE-G3-BAT-10.1P Battery SDS
Version Number:	V01
Revision Summary:	-
Current Revision Date:	19 Apr 2022

Alpha ESS Co., Ltd.

 +86 513 8060 6891
 info@alpha-ess.com
 www.alphaess.com
 Jiuhua Road 888, Nantong High-Tech Industrial Development Zone, Nantong City, 226300

Alpha ESS Suzhou Co., Ltd.

 +86 512 6828 7609
 info@alpha-ess.com
 www.alphaess.com
 Building 10-A, Canal Town Industrial Park, 99 Taihu E Rd, Wuzhong District, Suzhou 215000



Alpha ESS Europe GmbH

 +49 610 3459 1601
 europe@alpha-ess.de
 www.alphaess.de
 Paul-Ehrlich-Straße 1a, D-63225 Langen, Hessen



Alpha ESS Australia Pty. Ltd.

 +61 402 500 520 (Sales)
+61 1300 968 933 (Technical Support)
 info@alpha-ess.com
 www.alphaess.com



Alpha ESS Italy S.r.l.

 +39 339 462 4288
 info@alpha-ess.it
 www.alphaess.com
Via Don Minzoni, 17, Calenzano Firenze 50041



Alpha ESS Korea Co., Ltd

 info@alpha-ess.com
 2F, 19-4, Nohyeong 11-gil, Jeju-si, Jeju-do, Republic of Korea



Alpha ESS UK Co., Ltd

 +44 145 354 5222
 info@alpha-ess.com
 Drake House, Long Street, Dursley, gl11 4hh

Alpha ESS International Pte. Ltd.

 +65 6513 1125 / +65 6513 1126
 Singapore@alpha-ess.com
 2 Corporation Road #01-06A Corporation Place Singapore 618494

Alpha ESS USA, Inc.

 +1 408 368 7828
 usa@alpha-ess.com
 Unit 5 2180 S Ivanhoe St, Denver, CO 80222